

EX100-R-ADA-M Motorized Waist High Swing Gate Service & Installation Manual



Note: Successful turnstile installation depends on reading this manual.

Please keep this service manual after installation. If an installation is done by a construction company or outside installer, please pass this book along to the end user. This book is required for maintenance, troubleshooting & repairs.

Service Manual: 0740 E Gen. 3

Pre-installation Tips

To ensure an easy installation, please review the following tips before trying to install the unit.

Lid Removal

The top lid on most of our waist high models is held in place on the front side with a lock and two hooks that connect to the cabinet on the rear. After the lock has been released, the rear hooks can be unlatched from the by pulling the lid from the back side forward then pivoting upwards in one motion.

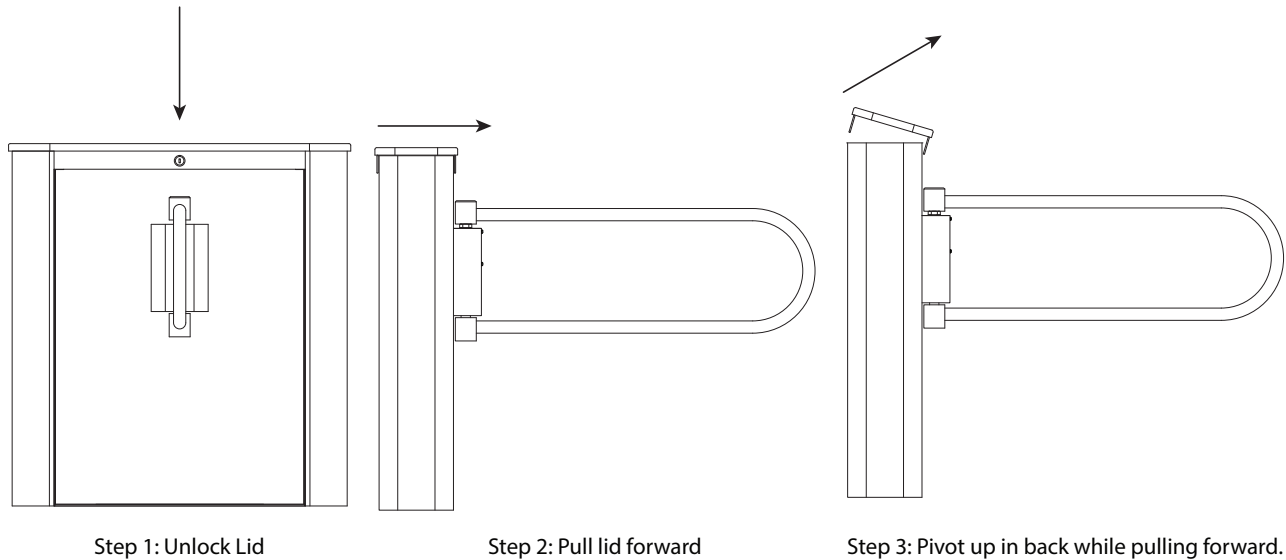

Front Panel Removal

In order to access the bolt holes for anchoring the cabinet to the floor, the decorative front panels need to be removed. The smaller V panel is held on with two 10/24 button head cap screws. The larger front panel can be taken out by removing the two 10/32 Phillips screws that connect the front panel to the cabinet located at the upper inside of the cabinet.

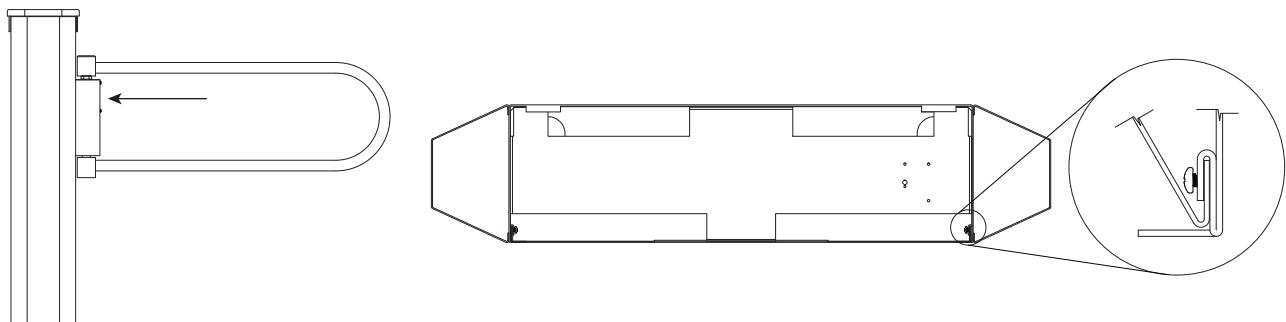

Generation 3 Chain Drive Motorized Gate Theory of Operation

The motorized gate is comprised of a modified 6500 series control head, a chain driven arm assembly with adjustable tension, a DC gearbox motor, a safety slip clutch, three proximity sensors and a motor controller.

When access is requested in a direction from access control, the motor will swing open in the appropriate direction until the relevant proximity sensor detects the location of the arm to stop the motor. Once an adjustable duration of time has expired, the arm will return to the home position.

If a second request to passage is presented, the timer will restart, keeping the motor in the open position. If the opposite direction is requested, the arm will just remain in the same open position it is in. Optional indicator lights reflect the status of the passage by changing from red to green while a direction is open.

Override inputs also exist in both directions. These inputs hold the arm open until the input is dropped. For the sake of indicator light status, both inputs can be triggered simultaneously. In this event, a setting determines which direction the arm will actually swing in.

During the standard input's timer duration, a quick pulse to an override input will cancel the input to bring the arm back to the home position. This can be a handy way to quickly close a monitored lane that someone feels should be closed immediately.

The internal solenoids allow for the arm to be locked into place so it can not be physically pushed open. However, if the motor is running and the locking bar has pressure against it, the motor will automatically reverse direction for a quick pulse to free this mechanical bind so the arm can open. If this occurs, the directional timer automatically restarts to give the full time duration of passage.

The solenoids can be pre-configured to either lock or unlock on power failure. If they are fail open and the power drops, the motor can be pushed open. Once power is restored, the arm will return to the home position.

Some final notes on the product:

Motorized chain drive gates are the only product manufactured by Controlled Access, Inc. that does not include a hydraulic shock. This is because the motor itself drives the speed of the arm.

While there are index springs on the control head, they are very light compared to most production models. If these springs need to be replaced for any reason, please specify it is for a chain drive motorized gate.

Motorized gates require alternate logic controller firmware to standard turnstiles. If the logic controller is being replaced, please specify it is for a motorized gate so that we can provide the appropriate firmware.

Wedge Type Concrete Anchor Instructions

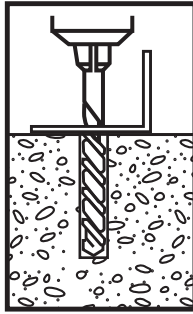

1

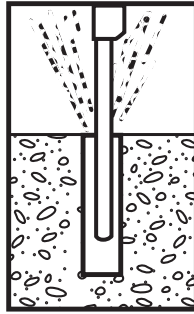

2



3

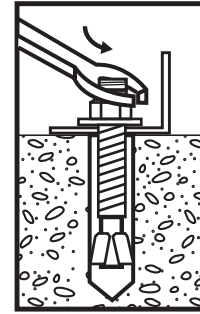

4

- 1** Select a carbide drill bit with a diameter equal to the anchor diameter. Drill hole at least 1/4" deeper than nominal anchor embedment.
- 2** Clean hole with pressurized air or vacuum to remove any excess dust/debris.
- 3** Using the washer and nut provided, assemble the anchor, leaving nut one half turn from the end of anchor to protect threads. Drive anchor through fixture to be fastened until washer is flush to the surface of fixture.
- 4** Expand anchor by tightening nut to the specified setting torque - see Table (approx 3 to 5 full revolutions).

Anchor Diameter & Drill Bit Size	Installation Torque Ft. lbs.*	Minimum Anchor Embedment	Minimum Hole Diameter in Fixture
3/8"	25	1-7/8"	1/2"
1/2"	45	2-1/2"	5/8"
5/8"	90	2-3/4"	3/4"

* Setting torque only applies at the time of installation.

Warning!

- ⚠** Use in concrete ONLY. Not recommended for use in lightweight masonry such as block or brick.
- ⚠** Always wear safety glasses and other necessary protective devices or apparel when installing or working with anchors.

Caution: Use of core drills is not recommended to drill holes for use with this anchor.

Do not use an impact wrench to set or tighten the anchor. Not recommended for use in concrete which has not had sufficient time to cure.

The use of carbide drill bits manufactured with ANSI B212.15 drill bit diameter requirements is recommended for installation of this anchor. Anchor spacing and edge distance (anchor installation locations) are the responsibility of the engineer of record.

Installing product in oversized holes is not recommended. Product will not set properly or achieve full designed load in oversized holes.

Waist High Cabinet Installation Instructions

Place upright cabinet with front panel removed onto a surface level +/- 1/16". If the surface is not level, the cabinet must be shimmed. Bolting a turnstile or ADA gate to an uneven floor may cause it to work improperly.

Mark or punch the floor in the four anchor holes on the floor plate and drill four 3/8" holes approximately 4" deep. Remove all concrete dust from the holes.

Place the cabinet back in its intended location and install with the provided 3/8" concrete anchors. Torque the nuts with a minimum of 25 foot pounds. If unsure, refer to the previous page for anchor installation tips.

If electronically controlled, install grounded electrical outlet within the cabinet and ground the power supply to the cabinet frame with provided grounding wire.

Install access control devices and/or fire alarm overrides to the control board with the wiring diagram provided later in this manual.

Install arm assembly (if applicable) to the arm adapter utilizing the three 5/16-18" socket head cap screws. We recommend applying removable strength (blue) thread sealant such as Loctite 243 to these screws.

Test the turnstile or ADA gate for proper functionality, making adjustments to the hydraulic shock absorber as needed (reference hydraulic shock information later in this manual).

Reinstall the front panel and lid on the cabinet then provide this manual to the end user or leave within the cabinet for future reference.

6500 Series Control Head Mechanical Information

All of our turnstiles and ADA gates operate with a mechanism called the 6500 Series Control Head. This sturdy and easy to maintain drive for the turnstile has replaced all previous model control heads. It is adaptable to nearly any existing turnstile and comes with each new turnstile purchase. This control head can be configured in multiple ways to accommodate the security requirements of each individual job site.

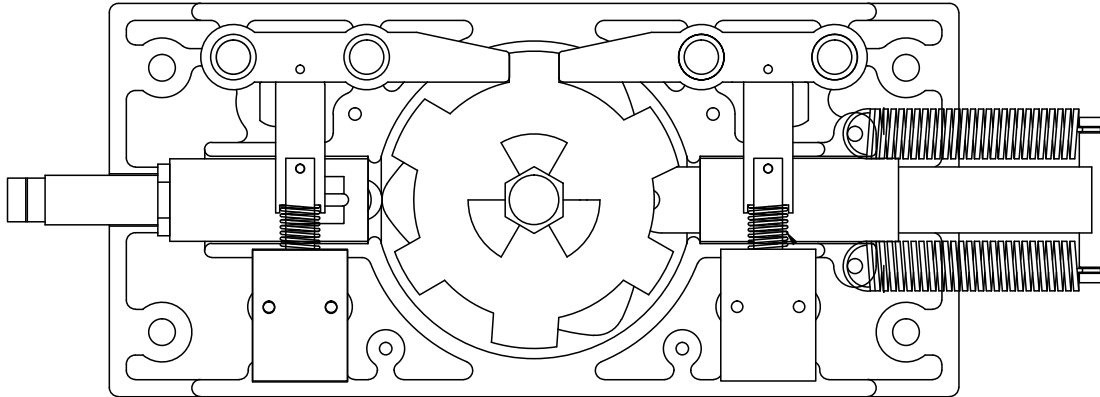

An internal view of an electronically controlled two way 6500 series control head.

While the head can be configured for mechanical (no electronics) operation, a turnstile's security potential is reached in the case of an electronic two way control head. In this instance, each rotational direction is independently unlocked. Configured properly, a control head will allow for one rotation per valid entry request. Our anti-backup cams are designed so that it is mechanically impossible to become trapped within the turnstile when properly installed.

Each control head comes preconfigured to your specific needs based off of a directional sheet that is filled out before shipment. The heads are delivered pre-wired, tested and adjusted to our factory recommendations. Installation is simple: connect inputs from access control devices into the logic controller and plug the unit's power supply into a 100-240 VAC (single phase) receptacle. The power supply will automatically set itself to function on your local voltage and convert it to 24VDC.

TOP CASTING REMOVED

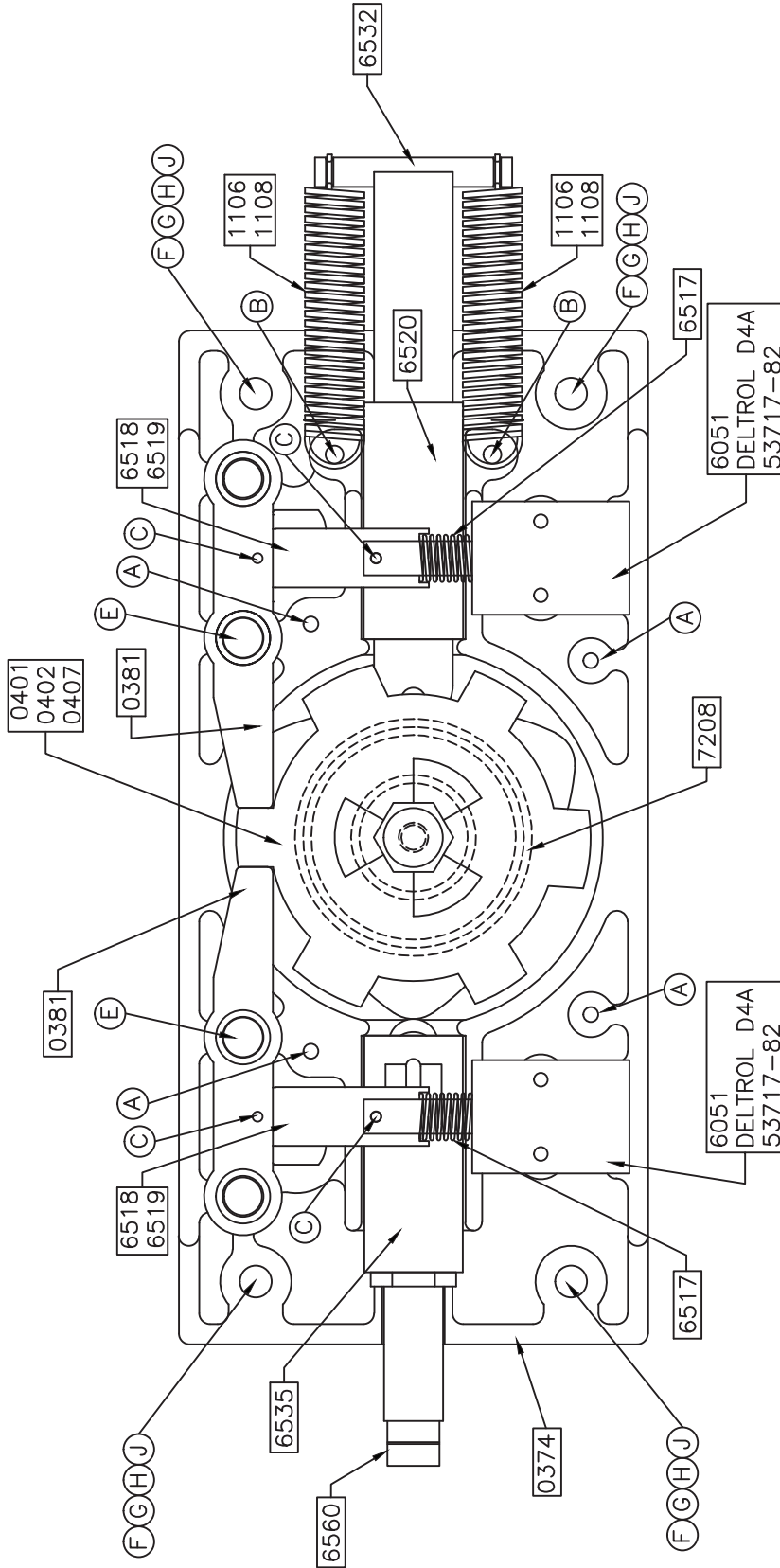

ALL ELECTRICAL COMPONENTS UL CERTIFIED







NOTE:
ALL WIRE AWG 18 GAUGE 300 VAC
UL 1007/1569

SYM	QTY	DESCRIPTION
(A)	4	1/4-20 x 1" SOCKET HEAD
(B)	2	1/4"φ x 1 1/4" SPRING PIN
(C)	4	1/8"φ x 5/8" SPRING PIN
(E)	2	1/2"φ X 2 1/4" DOWEL PIN

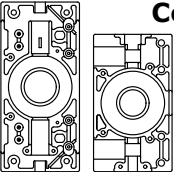
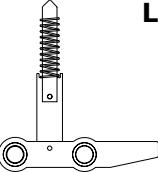
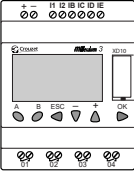
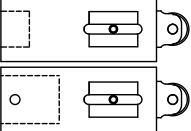
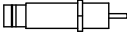
WAIST HIGH UNITS		
(F)	4	5/16 x 1-1/2" SS CARRIAGE BOLT
(G)	4	5/16 SS FLAT WASHER
(H)	4	5/16 SS LOCK WASHER
(J)	4	5/16 SS HEX NUT

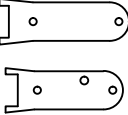
FULL HEIGHT UNITS		
(F)	4	3/8" x 1-1/2" SS CARRIAGE BOLT
(G)	4	3/8 SS FLAT WASHER
(H)	4	3/8 SS LOCK WASHER
(J)	4	3/8 SS HEX NUT

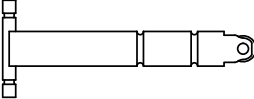
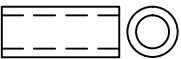
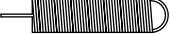
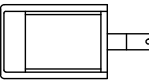
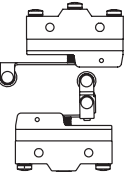
6500 SERIES CONTROL HEAD BOTTOM ASSEMBLY

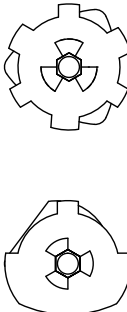
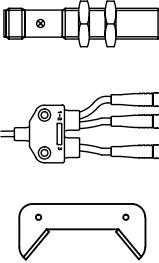
 <p>Control Head Castings 0373 - Bottom Casting 0372 - Top Casting</p>	 <p>Locking Bar Assemblies 0382 - Fail Open Assembly 0383 - Fail Lock Assembly</p>	 <p>0740 - Logic Controller (XD10)</p>
 <p>Shock Housing Assemblies 6535 - WH/427/430/T80/ADA 6541 - 439/448/P60/HD</p>	 <p>Hydraulic Shock Absorbers 6560 - WH/427/430/T80/ADA 6561 - 439/448/P60/HD</p>	 <p>0751 - 24VDC Power Supply (60 W) w/ NEMA 5-15 Drop Cord</p>
 <p>0381 - Locking Bar Casting w/ Oil Impregnated Bushings</p>	 <p>Locking Bar Linkages 6519 - Fail Open 6518 - Fail Lock</p>	 <p>Solenoid Springs 6510 - Fail Open Spring 6016 - Fail Lock Spring</p>
 <p>6532 - Index Pin</p>	 <p>6520 - Index Pin Tubing</p>	 <p>Indexing Springs 1106 - Waist High (Light) 1108 - Full Height (Heavy) 1107 - ADA (Extra Heavy)</p>
 <p>6051 - Solenoid Deltrol D4A53717-82</p>	 <p>Limit Switches 2180 - Standard (Z-15GW2-B7-K) 1700 - One Way (BZ2RW825-A2)</p>	 <p>Limit Switch Cams 2267 - Standard 2268 - ADA 2269 - One-Way</p>
 <p>Control Head Bearings 7208 - Bottom casting on all models (6007RSNR) 1641 - 1" ID for HS-22/439/448/P60/RD70/Pre 2018 Top Castings (1641-2RSNR) 1640 - 7/8" ID for WH/ADA/T80 and 7/8" hex cams sold after 2018 (1640-2RSNR)</p>	 <p>Cam Assemblies 0415 - All HS-22 Models/439/448/HD (1.25" Hex, Short) 0407 - P60 & RD70 Models (1.25" Hex, Long) 0401 - T80/WH/Legacy 427/430 (7/8 Hex Shaft) 0402 - ADA w/ Arm Adaptor 0416 - ADA w/ Chain Drive</p>	 <p>Proximity Sensor & Accessories 7211 - 24VDC PNP Prox. Sensor w/ M12 Connector (Sick 1040763) 0766 - 3 Branch M12 Splitter 6589 - Turnstile Prox. Bracket w/ 3x Mounts - LH, RH & Home</p>

6500 Series Control Head Configurations

The 6500 Series Control Head can be configured in a number of different ways. All units operating with the 6500 Series Control Head self-center with a spring driven indexing pin and hydraulically shock to the home position to prevent damage or injury.

Various configurations are available to suit the needs of any environment. These include:

Manual both ways: Unit rotates freely in both directions. This unsecure configuration is used as a means to direct traffic through one area. Full height turnstiles can be also be purchased with an out of service lockout bar which would allow the end user to lock the turnstile with a standard pad lock.

Manual one way: Turnstile rotates in one direction but not the other. This is often used for egress only areas.

Electronic one way with free exit: Unit rotates freely in one direction but requires some form of access control in the other. This is a typical installation in many facilities that want to control who is entering but want egress to be free flowing.

Electronic one way with no exit: Turnstile is locked in both directions at all times, but in one direction can be unlocked with access control. Typically, this would be installed in scenarios where there is an alternate means of exiting the facility.

Electronic two way: Turnstile requires access control for both entering and exiting a facility. This configuration offers the highest level of security and also flexibility for installations.

Fail lock: Upon power failure, an electronically controlled direction would remain locked. This offers a high level of security but typically is not a good idea for egress unless alternate methods of exiting are available. Unless equipped with key overrides, this can be easily converted to fail open by ordering alternate parts. This is also known as fail secure.

Fail open: Upon power failure, an electronically controlled direction would remain open. This is the most common configuration as it allows for secure access controlled passage in normal situations but in power outages it free wheels. Unless equipped with key overrides, this can be easily converted to fail lock by ordering alternate parts. This is also known as fail safe.

Key overrides: This option is available on either electronic or manual two way models. It can allow for a quick reconfiguration of free flowing passage or locking in either direction. The key override option is not intended for constant every day use. Should you require an additional lock-down feature on your turnstile, a better option (on a full height turnstile) is an out of service lockout with a standard pad lock. Note that the key override option makes conversion between fail lock and fail open very difficult to accomplish and also may not be available for some turnstile or gate models.

6500 Series Control Head Locking Bar Information

The 6500 Series Control Head is built to order based on a direction set up sheet sent with each quote. This sheet defines how each direction of passage functions.

Direction 1 is defined as clockwise rotation on a full height or with the cabinet on the right for waist high. Direction 2 is defined as counter-clockwise rotation on a full height or with the cabinet on the left for waist high.

Possible configurations include: no passage, free passage (manual), fail lock and fail open. Fail lock and fail open are not field reversible without additional components.

“No passage” directions include a fail lock locking bar assembly as well as an unwired solenoid. This adds the appropriate parts to the control head to prevent it from rotating in that direction.

“Free passage” (or manual) directions remove the solenoid and locking bar assembly, allowing the cam to spin freely.

Each direction has a pair of holes on the locking bar and control head casting. These holes act as pivot points for the locking bar casting. The inner holes are fail lock and outer holes are fail open. A .5” dowel pin slides through the entire assembly to hold everything in place.

Alternate linkages and springs are needed to convert a direction’s power failure status.

If optional key overrides are included, it becomes much more difficult to re-arrange the configuration. Typically it is best to send the control head into the factory to reconfigure any key override equipped head to ensure everything is done correctly.

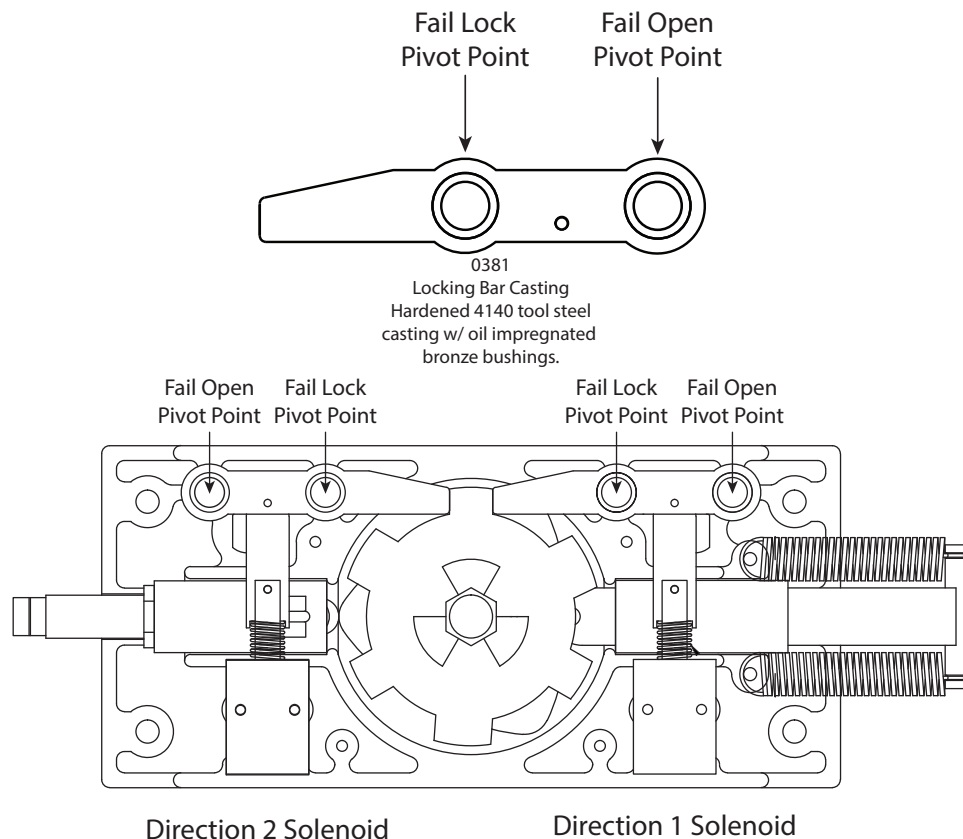

6500 Series Control Head Locking Bar Information (Continued)

The 6500 Series Control Head can be reconfigured from fail lock to fail open and vice versa. Extra components are required to do so.

If a control head has key overrides, we suggest sending it in for factory reconfiguration.

Locking bar assemblies are held together with 1/8" spring pins. Extracting these pins and reinstalling them can be tricky, so for convenience we also offer entire locking bar assemblies.

Replacing an entire locking bar assembly is simple; punch the .5" dowel pin from the pivot point through the head casting (via a small hole in the bottom casting for this purpose), pull out the old locking bar assembly and replace it with the new one.

If changing from fail lock to fail open or vice versa, install the dowel pin in the alternate hole.

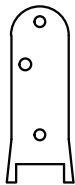

6518

Fail Lock Linkage
These have an approximate length of 2.25" and also include an extra hole the key override option.



6010

Fail Lock Solenoid Spring
These look the same as the fail open, but are actually lighter in force
Wire diameter is .032"
This spring was also used on the 6100 Series Control Head.

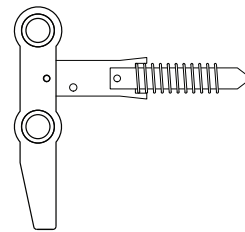

0383

Fail Lock Locking Bar Assembly
Includes locking bar casting w/ oil impregnated bushings, solenoid spring, locking bar linkage, and solenoid plunger.



6519

Fail Open Linkage
These have an approximate length of 2.5" and do not have the extra hole for the key override option.



6510

Fail Open Solenoid Spring
These look similar to fail lock, but are actually stronger in force.
Wire diameter is .041".

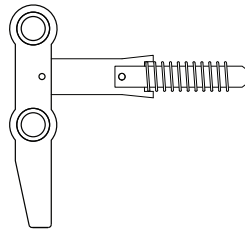

0382

Fail Open Locking Bar Assembly
Includes locking bar casting w/ oil impregnated bushings, solenoid spring, locking bar linkage, and solenoid plunger.

Make sure the solenoid spring is between the alignment tabs on the linkage or the assembly may bind when pivoting.

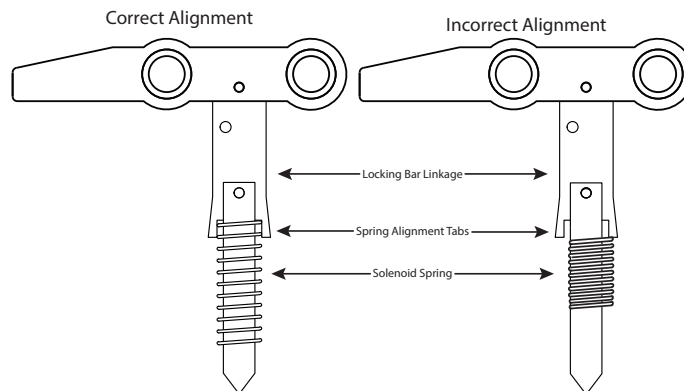

Generation 3 Chain Drive Motorized Gate Electrical Introduction

Each chain driven motorized gate comes with a power supply, a programmable logic controller (PLC), three proximity sensors, two solenoids and a motor controller. For safety purposes, it is recommended that you read all literature on the electrical components before attempting to connect to the product.

The chain driven motorized gate product is on its third generation of electronics. Like the previous generation, the controller utilizes PNP (sourcing) inputs. If the need to replace Gen 2 with Gen 3 components arises, it would be a simple transition. First generation installations would need to also purchase new proximity sensors to function correctly because the original controller used NPN (sinking) inputs.

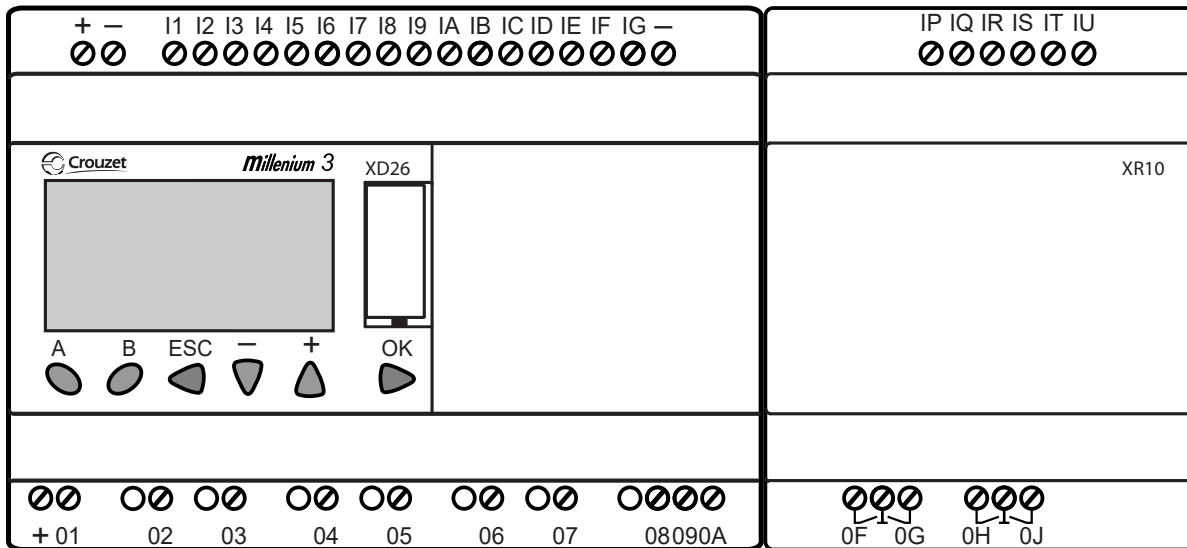

The product needs normally open contact closures between the relevant inputs in order to function. The normally open terminal from a relay would go to the relevant input while the common terminal needs to connect to 24VDC+. Separate inputs for each direction as well as access control vs. hold open are available to allow a variety of different functions depending on the need at the installation.

Generation 3 Chain Drive Motorized Gate Wiring Diagram

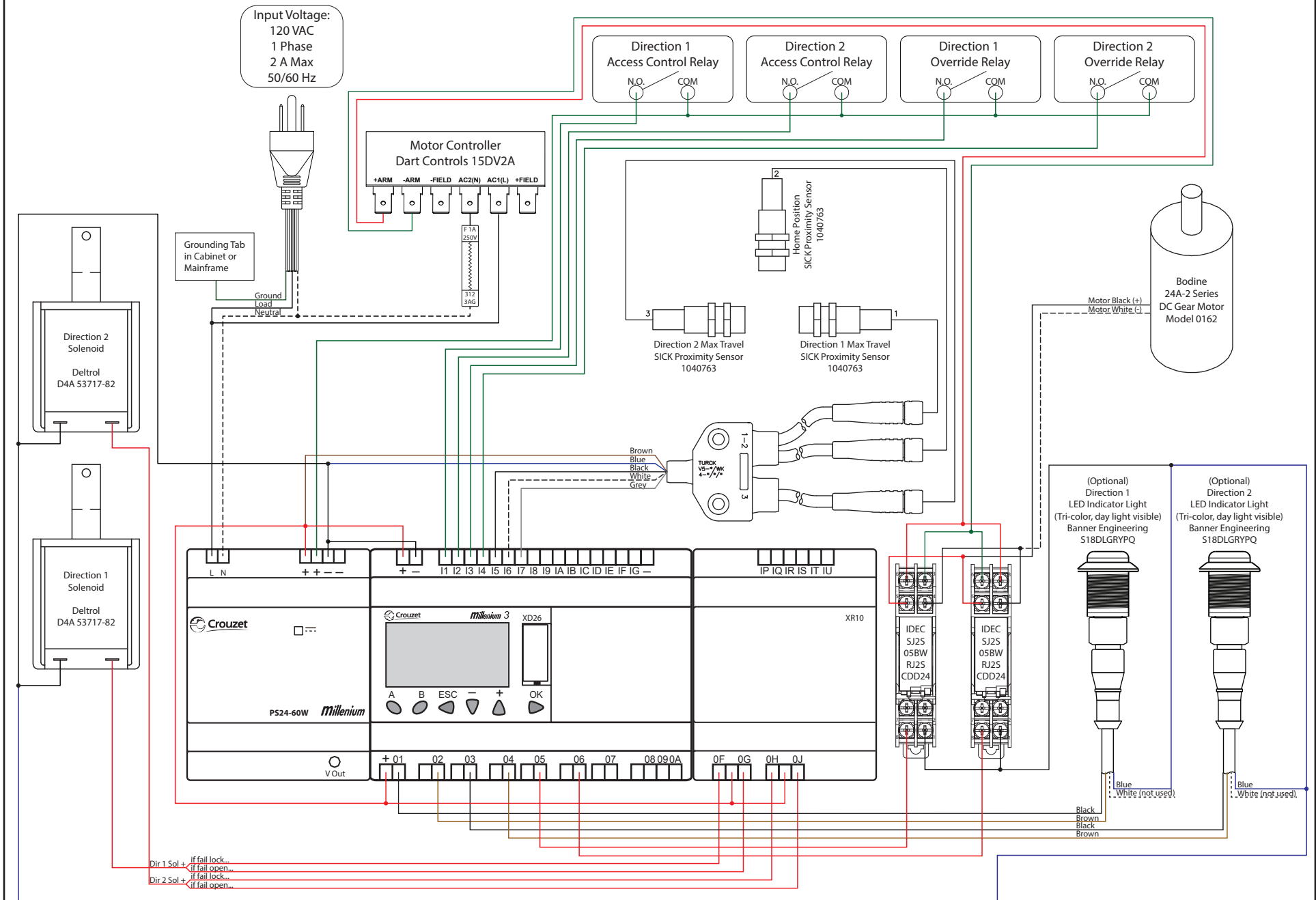

4/12/2018

Generation 3 Chain Drive Motorized Gate Wiring Legend

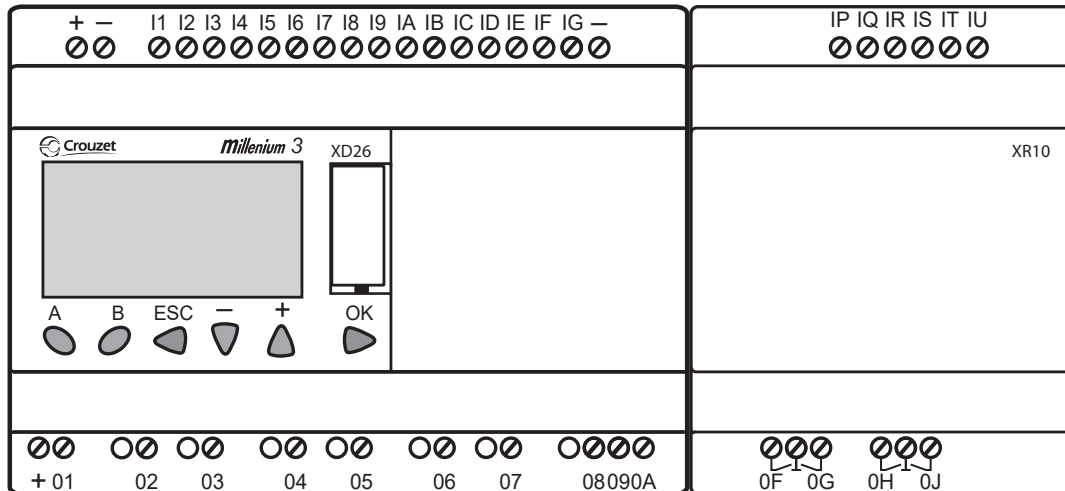

Each unit is built to order, preconfigured to function as specified at the time the order is placed. Some or all of the information listed may not be relevant to the installation.

Inputs are triggered with local 24VDC + (also known as PNP or sourcing). Connect relay output from access control device to turnstile by terminating 24VDC + to relay common and the desired input to the relay's normally open terminal.

Be sure to disconnect power before wiring the board for safety.

Input Descriptions:

+: 24VDC + Input from Power Supply

-: 24VDC - Input from Power Supply

I1: Direction 1 Input - Unlocks and swings arm open with the cabinet on the right hand side until the timer expires.

I2: Direction 2 Input - Unlocks and swings arm open with the cabinet on the left hand side until the timer expires.

I3: Direction 1 Override - Unlocks and swings arm open with the cabinet on the right until input is released.

I4: Direction 2 Override - Unlocks and swings arm open with the cabinet on the left until input is released.

I5: Direction 1 Max Travel Prox. - Stops the motor upon reaching fully open position with the cabinet on the right.

I6: Home Position Prox. - Stops the motor when closing once the home position is reached.

I7: Direction 2 Max Travel Prox. - Stops the motor upon reaching fully open position with the cabinet on the left.

All other inputs unused.

Output Descriptions:

+: Must be connected to 24VDC+

O1: Direction 1 Green Indicator Light - Indicates lane is open with the cabinet on the right.

O2: Direction 1 Red Indicator Light - Indicates lane is not open with cabinet on the right. Can also be wired yellow.

O3: Direction 2 Green Indicator Light - Indicates lane is open with the cabinet on the left.

O4: Direction 2 Red Indicator Light - Indicates lane is not open with cabinet on the left. Can also be wired yellow.

O5: Motor Clockwise - Activates the relay designated to turn the motor in the clockwise direction.

O6: Motor Counter Clockwise - Activates the relay designated to turn the motor in the counter clockwise direction.

OF: Direction 1 Solenoid Fail Lock - Prevents arm from swinging with the cabinet on the right unless energized.

OG: Direction 1 Solenoid Fail Open - Prevents arm from swinging with the cabinet on the right unless deenergized.

OH: Direction 2 Solenoid Fail Lock - Prevents arm from swinging with the cabinet on the left unless energized.

OJ: Direction 2 Solenoid Fail Open - Prevents arm from swinging with the cabinet on the left unless deenergized.

Outputs O7, O8, O9 and OA are not used.

Outputs on the XD26 are transistor PNP outputs. Outputs on the XR10 are relay outputs in which the commons are connected to 24VDC+. Voltage for other devices can be taken from these common terminals if needed.

The relay outputs on the XR10 are for operating the solenoids, which are too strong for the XD26 transistor outputs. The motor outputs on the XD26 activate external relays with arc suppression for longevity. One relay is for clockwise and the other relay is for counter clockwise. This is accomplished by reversing the voltage to the motor leads.

Generation 3 Chain Drive Motorized Gate Settings

Generation 3 chain driven motorized gates include a text based menu screen to adjust settings and view statistics of the gate. Pressing the A button will cycle to each of the screens available on the device. Pressing B from any screen listed will return to the Home Screen.

Home Screen

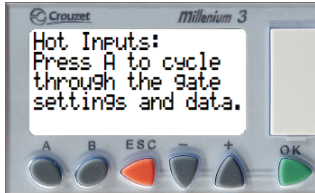

This screen is at the start of the menu cycle. The top section will give a read out of inputs that are currently receiving voltage. The display will return to this screen after cycling through all windows, 5 minutes of inactivity or pressing the B button.

Timer Values Screen

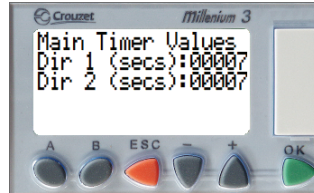

This screen allows for the each directional timer to be modified. Select which value you wish to edit by pressing the + & - key. Press OK to select the value then press + or - to modify. Save by pressing the OK button again. Each timer can have a value of 1 - 60 seconds. Once the timer expires, the motor will bring the arm back to the home position. These timers do not alter the override input functionality.

One-Shot Timers Screen

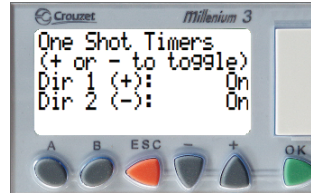

This screen allows for the two one-shot timer settings to be enabled or disabled. This setting prevents access control from holding open a direction on the standard direction inputs. Toggle Direction 1 by pressing + and Direction 2 by pressing -. This should be set to "On" in almost every installation.

Motor Delay Screen

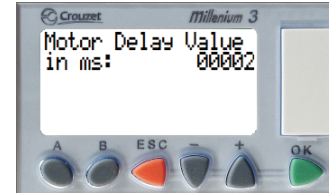

This screen allows for the modification of the setting which adds a delay after the motor moves before it can move in the opposite direction. This is mainly to protect the logic controller from shorting out the motor. This value can scale from 1 ms to 60 ms. Default value is 2 ms.

Primary Override Direction

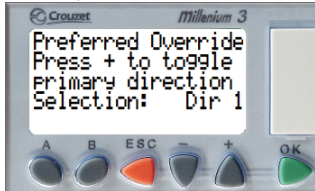

This setting defines which direction the arm will swing in the event both overrides are activated simultaneously. Typically this would be done in an emergency scenario such as a fire alarm. The benefit to activating both overrides is if the unit is equipped with indicator lights, both lights would be green instead of just the direction of swing.

Bind Recovery Settings

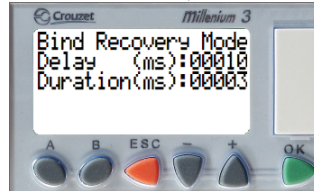

The motorized gate logic includes a function which briefly reverses the motor in the event of a mechanical bind against the locking bar. The delay before this occurs and the duration of reverse time can be adjusted here. The default delay is 10 ms and the default duration is 3 ms. These settings shouldn't be altered without guidance from tech support.

Testing Mode Screen

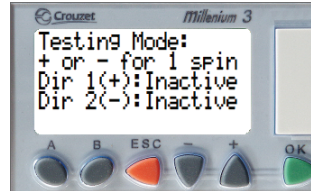

While this screen is active, the unit can be tested with push buttons to simulate access control inputs. See the page dedicated to testing for more information.

Direction 1 Counts Screen

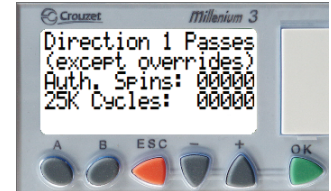

This screen gives statistics about how many times direction 1 was activated and cycled. Since there is a limit to how many counts can be displayed, after 25000 cycles the first counter resets and adds to the second counter.

Direction 2 Counts Screen

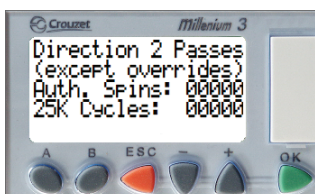

This screen gives statistics about how many times direction 2 was activated and cycled. Since there is a limit to how many counts can be displayed, after 25000 cycles the first counter resets and adds to the second counter.

Bind Recovery Statistics

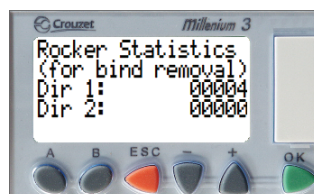

This screen displays how many times the motor rocked the arm in the event of a mechanical bind for each direction. This information may be useful to technical support.

General Info Screen

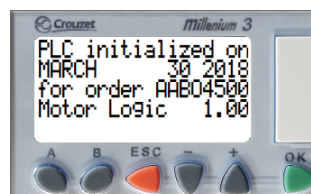

This screen displays when the PLC was initiated, the order number it was activated for (except for any revision suffixes which are not needed for order lookup), and the PLC software version.

Factory Setup Screen

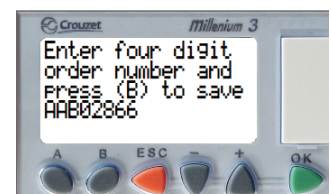

This screen should only appear when first set up in the factory or if something occurs to totally reset the logic controller. If this manages to occur and the order number (if known), enter it as a value then press B to save.

Generation 3 Chain Drive Motorized Gate Testing Procedures

The XD10 logic controller on the 6500 Series Control Head can be activated by contact closures between 24VDC+ and the relevant input. New technology allows for simpler on-board testing as well. To diagnose issues with the unit, press A on the keypad to cycle between screens until the testing mode screen appears.

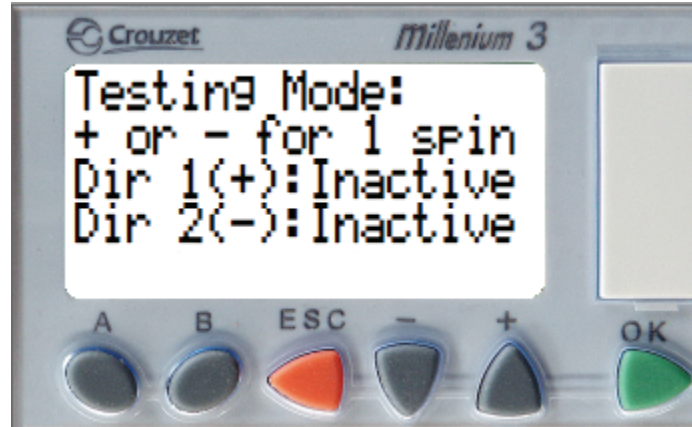

Testing mode simulates valid access control inputs based on the settings defined on the other menu screens. The unit should swing open for the duration of the directional timer. If the button is again before the arm returns home, the timer should restart. If the arm is open and the alternate direction is pressed, the timer will restart and the other indicator light will also turn green. If the button is held and the one shot timers are disabled, the unit will continue to remain open until the button is released and the timeout occurs.

With the testing mode screen open, press and release + to activate in direction 1. The unit should unlock and open the gate for the defined timer duration. If the unit successfully functions this way, repeat the same for direction 2 by pressing the - button.

If everything is functioning properly from the menu test but not with access control, either access control is not connected properly, is normally closed instead of normally open, or is not properly configured. Contact a security integrator for assistance with help with the access control system.

If there are other issues with operation, check out the troubleshooting guide for additional diagnostic procedures or call Controlled Access, Inc. for assistance.

ADA Gate Chain Drive Tensioning

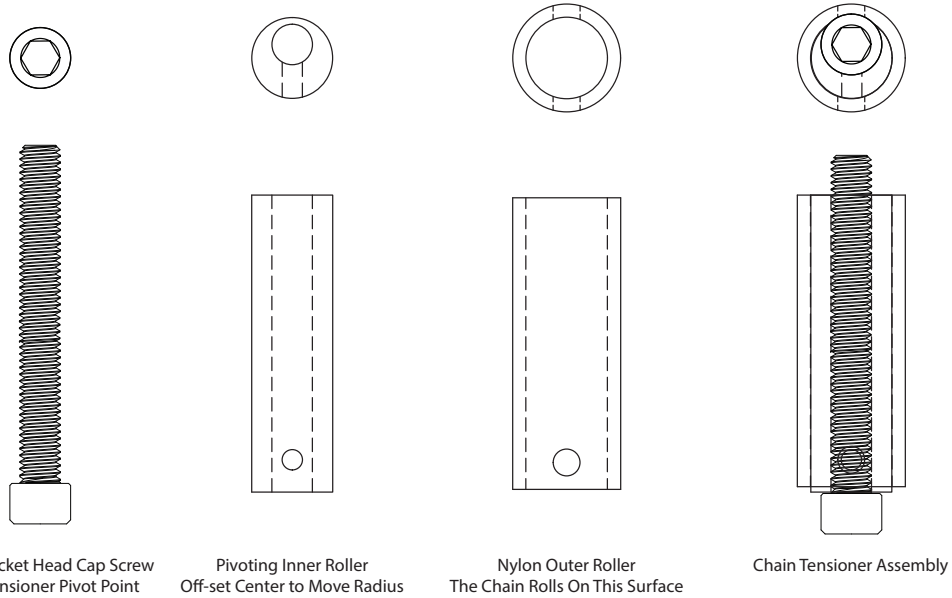

By loosening the socket head cap screw and aligning the side holes on the inner and outer roller with a screwdriver or similarly sized tool, it is possible to change the location of the rollers in relation to the chain, effectively providing a way to adjust the chain's tension.

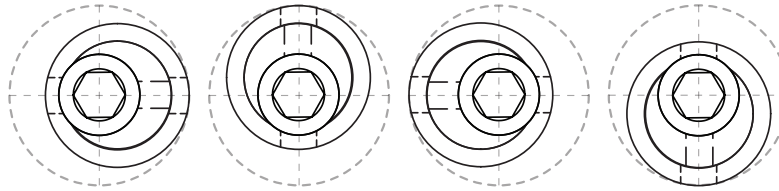

Illustrated above is the same dashed circle with a chain tensioner assembly adjusted to four 90 degree increments. While the outer radius changes, the inner pivot point remains the same.

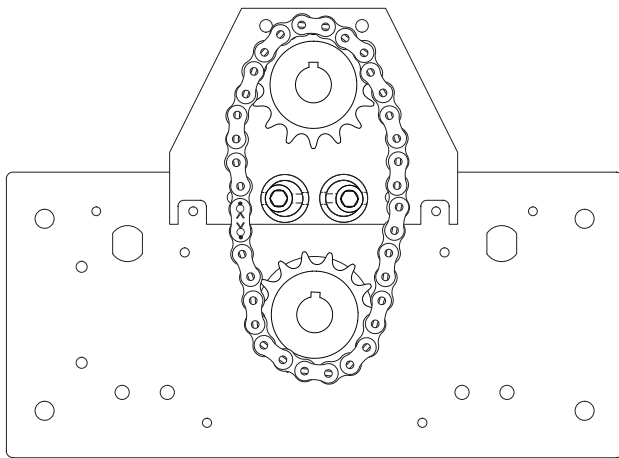

Loose Chain

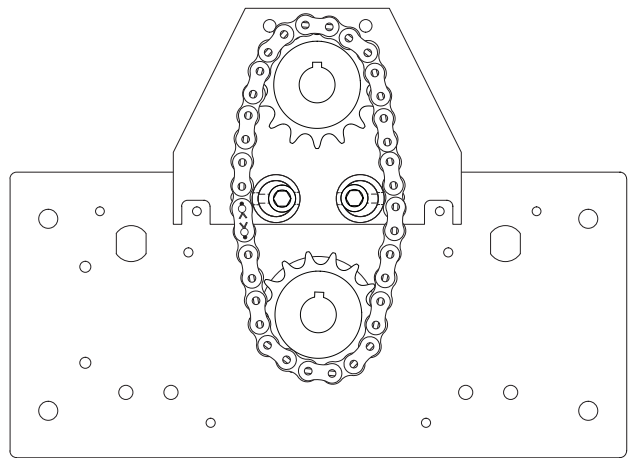

Tensioned Chain

15DVP CONTROL SERIES

DART

CONTROLS

Instruction Manual

Adjustable Speed DC Control



**P.O. Box 10
5000 W. 106th Street
Zionsville, Indiana 46077**

**Phone (317) 873-5211
Fax (317) 873-1105
www.dartcontrols.com**

Model 15DVP

Please read and save these instructions. Read carefully before attempting to assemble, install, operate or maintain the product described. Protect yourself and others by observing all safety information. Failure to comply with instructions could result in personal injury and/or property damage! Retain instructions for future reference.

Description

The 15DVP is an adjustable speed DC motor control and is designed for applications requiring constant (or diminishing) torque, such as conveyors, fans, blowers, pumps, mixers, etc.

It is designed to operate only one DC motor. This control is a general purpose, economical variable speed control for small DC and universal motor applications featuring: dual input voltages 120/240 VAC, power On/Off toggle switch, adjustable trimpot settings, quick connect terminal pins, and packaged in a small Nema 1 enclosure.

Control Features

- Dual voltage model 120/240 VAC input
- Output voltage 0-90/180 VDC
- Full wave bridge power supply
- Adjustable Minimum speed (0-30% of max)
- Adjustable Maximum speed (40-115% of base)
- Adjustable IR Compensation
- Fixed Acceleration (0.5 seconds)
- 25:1 speed range
- 1% speed regulation
- Shunt field supply provided (.75 Amp max) - 100V for 120 VAC; 200V for 240 VAC Input
- Overload capacity of 200% for 1 minute
- Transient voltage protection
- Power on/off switch

WARRANTY

Dart Controls, Inc. (DCI) warrants its products to be free from defects in material and workmanship. The exclusive remedy for this warranty is DCI factory replacement of any part or parts of such product which shall within 12 months after delivery to the purchaser be returned to DCI factory with all transportation charges prepaid and which DCI determines to its satisfaction to be defective. This warranty shall not extend to defects in assembly by other than DCI or to any article which has been repaired or altered by other than DCI or to any article which DCI determines has been subjected to improper use. DCI assumes no responsibility for the design characteristics of any unit or its operation in any circuit or assembly. This warranty is in lieu of all other warranties, express or implied; all other liabilities or obligations on the part of DCI, including consequential damages, are hereby expressly excluded.

NOTE: Carefully check the control for shipping damage. Report any damage to the carrier immediately. Do not attempt to operate the drive if visible damage is evident to either the circuit or to the electronic components.

All information contained in this manual is intended to be correct, however information and data in this manual are subject to change without notice. DCI makes no warranty of any kind with regard to this information or data. Further, DCI is not responsible for any omissions or errors or consequential damage caused by the user of the product. DCI reserves the right to make manufacturing changes which may not be included in this manual.

Dart DC Motor Control

Dimensions

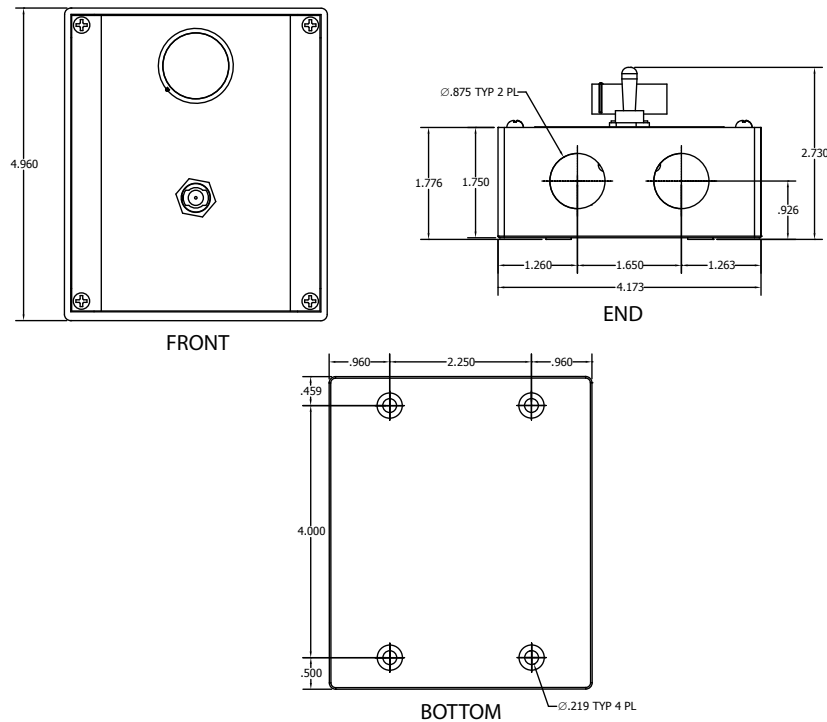

Figure 2

Specifications

AC Input Voltage	± 10% Rated Line Voltage
Input Voltage -	120 VAC or 240 VAC
Output	0-90Vdc (1/50 - 1/6 HP) or 0-180Vdc (1/25 - 1/3 HP)
Amps - Continuous DC Output	150mA to 2 Amps
Input Frequency	50 / 60 Hertz
I.R. Compensation	Adjustable - full range
Max. Speed	Adjustable (40 - 115% of Base Speed)
Min. Speed	Adjustable (0 - 30% of Max)
Output Voltage MAX - (120 or 240 VAC Input)	105/210 VDC
Overload Capacity	200% for 1 minute
Shunt Field Voltage75 Amp max, 100 VDC at 120 VAC
.....	.75 Amp max, 200 VDC at 240 VAC
Speed Control	5K Ohm Speed Potentiometer
Speed Range	25:1
Speed Regulation	± 1% of Base Speed
Temperature Range	-10° to 40° C. Ambient (15° to 105° F.)
Transient Protection	G-Mov
Dimensions	4.173" wide, 4.960" high, 2.730" deep
Weight	10.40 oz.

Model 15DVP

Application Information

If replacing another motor with this control and a DC motor, make sure that the full load torque rating of the DC motor is equal to, or greater than, the full load torque rating of the motor being replaced. Take into consideration how much starting torque is required.

If high voltage surges (transients) are present on the AC supply lines for the control, protect the control by installing an isolation transformer or other line filtering.

⚠ WARNING

Do not operate the control near high capacitive discharge equipment such as electrical welders.

This control does not have a current/torque limit feature. A DC motor can develop a starting torque of up to 600% of its full load rating. A line fuse should be used to protect against continuous overload. For proper fuse sizing, see Fuse Selection Table.

⚠ CAUTION

Tampering with or any attempt to modify this control will void the warranty. Incorrect wiring and accidental grounds will seriously damage the control and/or motor and will void the warranty.

General Safety Information

⚠ WARNING

Disconnect power before installing or servicing.

1. Lock and tag the power disconnect to OFF to prevent unexpected

application of power.

2. Follow all local electrical and safety codes as well as the National Electrical Code (NEC) and the Occupational Safety and Health Act (OSHA).
3. Motor and control must be securely and adequately grounded. This can be accomplished by wiring with a grounded, metal-clad raceway system, by using a separate ground wire connected to the bare metal of the motor and control frame, or other suitable means. Refer to NEC Article 250 (Grounding) for additional information.
4. Provide guarding for all moving parts.
5. Do not touch the frame of an operating motor or control. When fully loaded they may run at very hot temperatures. Modern-designed motors normally run hot at rated voltage and load.
6. Protect the power cable from sharp objects.
7. Do not kink the power cable, and never allow it to touch oil, grease, hot surfaces, or chemicals.
8. Make certain that the power source conforms to the requirements of your equipment.
9. Keep dirty cleaning rags and flammable waste materials in a tightly closed metal container or dispose of in the proper fashion.
10. If needed, clean the front of the control enclosure with a mild solution.

Installation

⚠ WARNING

Motor shaft keyway edges may be sharp and it is recommended that only qualified electricians or service people should install, troubleshoot, maintain, or service the control, motor, and interconnect wiring.

MOUNTING

⚠ WARNING

Do not install the control and motor where the atmosphere is (or may become) explosive.

Mount the control firmly to a flat, rigid metal surface using No. 10 hardware. (Refer to Figure 2). Avoid mounting surfaces which vibrate excessively, such as on punch presses or similar equipment. Make sure the air temperature will not be higher than 40°C (104°F) in the mounting location.

⚠ CAUTION

Do not mount the control in locations where liquids can spray or drip on it, or where there is moisture, oil, dirt, or other foreign materials (sawdust, metal particles, etc.) in the air. For such environments, the manufacturer suggests mounting the control within a sealed enclosure.

CONNECTION

⚠ WARNING

Disconnect power source before connecting control or motor.

1. Use only copper wire rated 70°C or better.
2. Size motor armature and AC line conductors according to all National, State, and Local codes.
3. Minimum recommended wire size is No. 16 AWG for control input lines, and for interconnection lines between control and motor.

Dart DC Motor Control

Connection

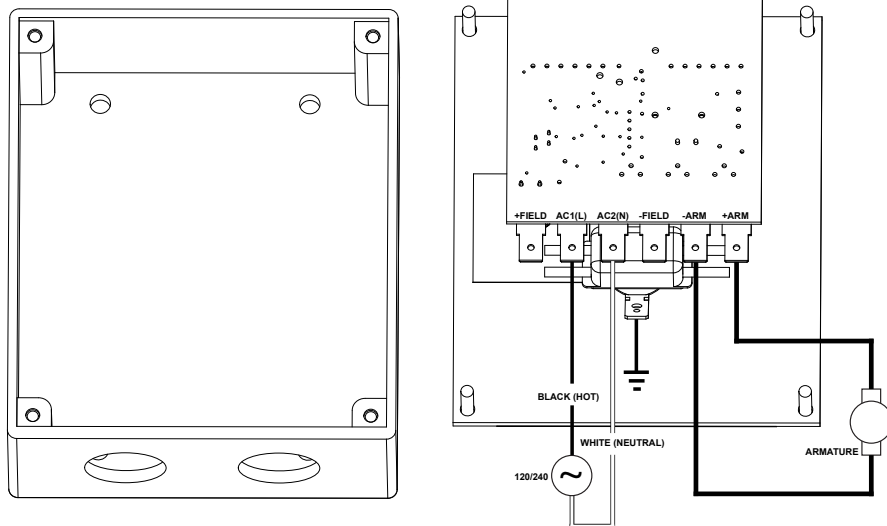

Figure 3 - Control Terminal Connectors

Make connections to the control and the motor in accordance with the Connection Chart. The control terminal 1/4" spades (Figure 3) are located inside the control enclosure on the PC board. To ground the control mounting plate, connect ground wire to the ground terminal located on the on/off switch

⚠ WARNING

Do not connect control AC power inputs to DC lines.

⚠ CAUTION

Never lay control cover plate with component side down on any conductive surface.

FUSE SELECTION

The control is shipped without fusing or breaker protection. An inline fuse should always be added to hot AC on 120VAC or both lines on 240VAC. Select and install fuses sized per the Control Fuse Selection Table below.

⚠ CAUTION

Incorrect fusing current or voltage rating will cause either inadequate protection or nuisance fuse blowing.

CONTROL FUSE SELECTION TABLE

MOTOR RATING	LINE FUSE
1/6 HP	4 Amp
1/8 HP	3 Amp
1/35 - 1/10	2 Amp
1/50 - 1/40	1 Amp

BASIC CONTROL SETUP

1. Safety Precautions:

- Observe the normal safety precautions for the voltages involved. It is strongly suggested that only qualified electricians or service people should install, troubleshoot, maintain, or service the control, motor, and interconnect wiring.
- Be sure power is disconnected or shut OFF at fuse box or circuit breaker when installing the control and making adjustments (except running adjustments).
- Remove the load from motor (or gearmotor) before running it.
- Use an insulated screwdriver to make trimpot adjustments.

⚠ CAUTION

When making running adjustments, be very careful not to touch any components except the adjusting pots.

- On the control front panel, turn the control ON-OFF switch to off and set the control pot knob fully counterclockwise (CCW) and check line fuse.

NOTE: The fuse should be as specified by the Control Fuse Selection Table.

- Check all the connections at the control terminals and at the motor. Make sure that they are tight and are made according to Figure 3 and the Connection Chart.
- Rotate the motor's shaft manually to make sure it turns freely. A slight resistance may be noticed.

Model 15DVP

5. Turn the control ON-OFF switch to the ON position and then slowly turn the Speed Control knob clockwise (CW) while observing direction of motor rotation. If opposite direction of rotation is desired, correct by turning OFF the control and then reverse the motor armature connections. Reverse the connection either at the control or at the motor, wherever is most convenient.
6. With AC line power and control back ON; slowly turn Speed Control knob fully CW while observing the motor. Motor should accelerate smoothly to top speed.
7. Turn OFF control and AC power to control.
8. Reconnect the motor load that the motor will normally drive.
9. Turn AC power and the control back ON, then test the control and motor under actual operating and load conditions; run the motor through the entire range of speeds required while it is fully loaded. Check motor speed with a tachometer.

If control/motor performance is not satisfactory, continue adjusting the control by following the procedures given in the next section, "Special Control Setup".

SPECIAL CONTROL SETUP

Use applicable sections of the following procedures if the "Basic Control Setup" procedures do not provide satisfactory motor/control performance.

1. Follow the Safety Precautions given in paragraph 1 of "Basic Control Setup Procedure".

Max Setting

2. If a different maximum speed or voltage is desired, adjust the MAX trim pot (on circuit board) as follows:
 - a. Turn ON AC power to the control
 - b. Set Speed Control knob fully (100%) CW
 - c. Check motor speed and voltage with a tachometer and a DC Voltmeter.
 - d. Using an insulated handle 1/8" blade screwdriver, adjust the MAX trim pot on the control PC board. (See Figure 4 for location.) Clockwise adjustment of the pot increases the maximum output to the motor; counterclockwise adjustment decreases the maximum output to the motor.

NOTE: Do not increase maximum motor speed above 1800 RPM for motors rated at 1725 RPM. Do not operate motor continuously above the rated DC voltage.

Min Setting

3. If a minimum speed is desired, adjust as follows:
 - a. Turn ON AC power to the control.
 - b. Turn Speed Control knob CCW as far as possible.
 - c. Check motor output speed or voltage
 - d. Adjust the MIN trim pot on the control PC board. (See Figure 4 for location.) Clockwise adjustment of the pot increases output to the motor; counterclockwise adjustment decreases.

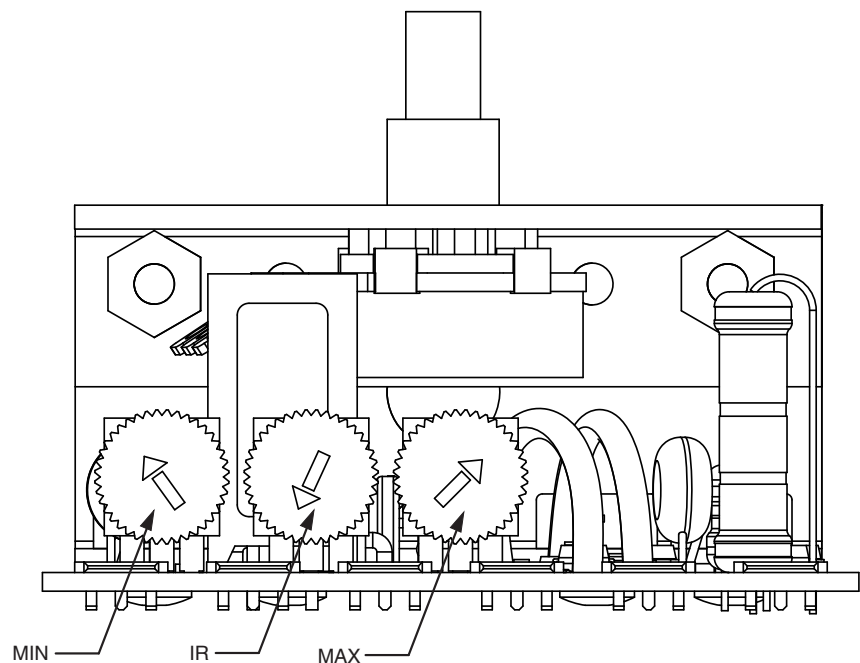

Figure 4 - Control Trimpot Adjustment Location

Dart DC Motor Control

SPECIAL CONTROL SETUP (CONTINUED)

NOTE: Typically the MIN pot should be set at Deadband which is the point in the CW rotation just before getting an output.

IR Setting

4. If better speed regulation is needed, then adjust the IR pot as follows:
 - a. Set speed at 50%
 - b. Check speed with Tach at no load
 - c. Apply normal load to the motor
 - d. Adjust the IR pot CW to increase speed regulation or CCW to decrease speed regulation until loaded motor speed is equal to unloaded motor speed.

NOTE 1: Adjustments made to any of the MIN, IR, and MAX trimpots may affect the settings of the other trimpots. It may be necessary to repeat the setup of each trimpot several times to achieve optimal tuning.

NOTE 2: Motor speed variations amounting to +/-5% of motor base speed, or less, are normal during operation at any set speed; you may not be able to eliminate them. (Base speed is the speed at which the motor, or motor portion of a gearmotor, runs when driven at rated armature voltage with rated load.)

OPERATION PRECAUTIONS

⚠ CAUTION

This control is intended to drive motors used in constant (or diminishing) torque applications, such as on conveyors, fans, blowers, pumps, mixers, etc.

⚠ WARNING

Do not operate the control near high capacitive discharge electrical circuits, such as electrical welding machines.

⚠ WARNING

Regardless of motor speed, do not allow the torque load on the motor to exceed the motor nameplate full-load torque rating, for extended periods of time.

OPERATING PROBLEMS

Most motor problems are caused by one of the following conditions:

1. Loose connections at control or motor.
2. Overloading motor.
3. Low voltage at motor input terminals caused by one of the following conditions:
 - a. Control AC input lines are undersized (conductors too small), or are too long for conductor size used.
 - b. Control DC output lines to motor are undersized or too long

Always check connections, load, and supply circuits if motor fails to perform satisfactorily. Although the control is designed to operate on the AC voltage/frequency specified on its nameplate, it will also operate safely under normal motor loading conditions, on AC voltages/frequencies up to 10% higher or lower than that specified. For heavy motor loads, however, do not operate the control on AC voltages lower than the specified nameplate voltage. Some common causes of low voltage not previously mentioned are:

1. AC supply circuits overloaded by lights, electrical appliances, or other motors.
 2. Low incoming line voltage caused by distribution system overloads.
 3. Undersized AC lines in building where control is being used.
- Some effects of low voltage are:
1. Motor power loss.
 2. Slow motor starting.
 3. Slow motor running (won't reach top speed).
 4. Motor overheating
 5. Frequent fuse blowing and/or circuit breaker tripping

NOTE: Effects 2 through 5 can also be caused by motor overloads.

MAINTENANCE

⚠ WARNING

Make certain that the power supply for the control is disconnected before attempting to service or remove any components. Lock the AC power disconnect in the open position and tag it to prevent unexpected application of power. Only a qualified electrician or service person should perform any electrical troubleshooting or maintenance.

⚠ CAUTION

Incorrect wiring and accidental ground will seriously damage the control and/or motor, and will void the warranty.

CONTROL

The control chassis should be periodically inspected to prevent an accumulation of materials which might block the flow of cooling air.

REPAIR PROCEDURE

In the event that a Product manufactured by Dart Controls Incorporated (DCI) is in need of repair service, it should be shipped, freight paid, to: Dart Controls, Inc., 5000 W. 106th Street, Zionsville, IN. 46077, ATTN: Repair Department. Please include Name, Shipping Address (no P.O. Box), Phone Number and if possible, e-mail address.

Those orders received from anyone without an existing account with DCI must specify if they will be paying COD or Credit Card (Master Card/Visa/American Express). This information is required before work will begin. If you have an account with Dart your order will be processed according to the terms listed on your account. Products with Serial Number date codes over 5 years old will automatically be deemed Beyond Economical Repair (BER). A new, equivalent device will be offered at a substantial discount.

Completed repairs are returned with a Repair Report that states the problem with the control and the possible cause. Repair orders are returned via UPS Ground unless other arrangements are made. If you have further questions regarding repair procedures, contact Dart Controls, Inc. at 317-873-5211.

YOUR MOTOR SPEED CONTROL SOLUTIONS PROVIDER

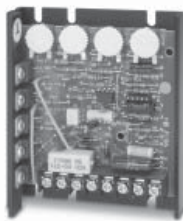

125D SERIES
AC INPUT - VARIABLE DC OUTPUT
1/50 HP through 1.0 HP



250G SERIES
AC INPUT - VARIABLE DC OUTPUT
1/50 HP through 2.0 HP



65 SERIES
DC INPUT - VARIABLE DC OUTPUT
CURRENT RATINGS OF 20, 40, AND 60 AMPS



700/COMMUTROL SERIES
DC BRUSHLESS
5 & 20 Amp for
12,24,& 36VDC Inputs



MDP SERIES
PROGRAMMABLE
CLOSED LOOP DC
SPEED CONTROL



DM SERIES
FIELD PROGRAMMABLE
DIGITAL TACHOMETER

Dart Controls, Inc. is a designer, manufacturer, and marketer of analog and digital electronic variable speed drives, controls, and accessories for AC, DC, and DC brushless motor applications.

Shown above is just a sampling of the expanded line of Dart controls that feature the latest in electronic technology and engineering. Products are manufactured in the U.S.A. at our Zionsville (Indianapolis,

Indiana) production and headquarters facility - with over 2,000,000 variable speed units in the field.

In addition to the standard off-the-shelf products, you can select from a wide variety of options to customize controls for your specific application. For further information and application assistance, contact your local Dart sales representative, stocking distributor, or Dart Controls, Inc.

Dart Controls, Inc.

Manufacturer of high quality DC and AC motor speed controls and accessories since 1963.

P.O. Box 10
5000 W. 106th Street
Zionsville, Indiana 46077
Phone: (317) 873-5211
Fax: (317) 873-1105

www.dartcontrols.com
ISO9001:2008 REGISTERED